

# ***ENERGYLINE PRO***

**SWIMMING POOL HEAT PUMP UNIT**



**Installation & Instruction Manual**

# CONTENTS

---

<b>1. Preface</b>	<b>1</b>
<hr/>	
<b>2. Specifications</b>	<b>2</b>
2.1 Technical data for the swimming pool heat pump unit	2
2.2 Operating range	3
2.3 Dimensions	4
<hr/>	
<b>3. Installation and connection</b>	<b>5</b>
3.1 Functional diagram	5
3.2 Heat pump unit	6
3.3 Hydraulic connection	6
3.4 Electrical connection	7
3.5 Initial start-up	8
3.6 Water flow setting	10
<hr/>	
<b>4. User interface</b>	<b>11</b>
4.1 Overview	11
4.2 Clock function/settings	13
4.3 Tuner function/settings	13
4.4 Operation mode selection: heating or cooling	14
4.5 Setting and visualisation for the set point	15
4.6 Locking and unlocking the touch screen	15
<hr/>	
<b>5. Maintenance and Winterising</b>	<b>16</b>
5.1 Maintenance	16
5.2 Winterising	16
<hr/>	
<b>6. Appendix</b>	<b>17</b>
6.1 Electrical Diagrams	17
6.2 Heating priority wiring	22
6.3 Exploded view and spare parts	24
6.4 Troubleshooting guide	34
6.5 Warranty	35

Please read attentively and save for future consultation.

This document must be given to the pool owner and should be kept in a safe place.

# 1. PREFACE

---

We thank you for purchasing this Hayward swimming pool heat pump unit. This product was designed according to strict manufacturing standards to satisfy the required quality levels. This manual includes all of the necessary information concerning installation, debugging and maintenance. Please attentively read this manual before opening the unit or before carrying out any maintenance operations on it. The manufacturer of this product will not, under any circumstances, be held responsible in the case of injury to the user or damage to the unit resulting from improper installation, debugging or unnecessary maintenance. It is essential to follow all of the instructions specified in the manual at all times. The unit must be installed by a qualified professional.

- Repairs must be made by a qualified professional.
- All electrical connections must be made by a qualified electrician according to standards in the country of installation see § 3.4.
- Maintenance and the different operations must be carried out at the recommended times and frequencies as specified in this manual.
- Only use genuine spare parts.
- Failure to comply with these recommendations will invalidate the warranty.
- This swimming pool heat pump unit heats swimming pool water and maintains a constant temperature; it should not be used for any other purpose.

After having read this manual, keep it for future usage.

Warnings concerning children/people with reduced physical capacity:

This appliance is not intended to be used by persons (especially children) with reduced physical, sensory or mental capabilities or by persons who lack experience or knowledge, unless they are under supervision or have received instructions concerning the use of the appliance by a person responsible for their safety.

This product contains greenhouse effect fluorinated gases covered by the Kyoto protocol.

Type of refrigerant: R410A

GAP Value<sup>(1)</sup>: 1975

Periodic inspections for refrigerant leakage can be required as a function of European or local legislation. Please contact your local distributor for additional information.

---

(1) Potential for global warming

## 2. SPECIFICATIONS

### 2.1 Technical data for the swimming pool heat pump unit

Models	ENERGYLINE PRO	ENP1M	ENP2M	ENP3M	ENP4M	ENP5M
Heating capacity*	kW BTU/h	5,9 20140	7,9 27000	11 37570	12,5 42690	15 51225
Absorbed electrical power	kW	1,4	1,8	2,4	2,9	3,4
Running current*	A	6,4	8,2	11,3	13,1	14,9
Power supply	V	230 V~	230 V~	230 V~	230 V~	230 V~
aM type fuse calibre	Pb/Hz A	1/50Hz 10 aM	1/50Hz 12 aM	1/50Hz 16 aM	1/50Hz 20 aM	1/50Hz 25 aM
Curve D circuit breaker	A	10 D	12 D	16 D	20 D	25 D
Compressor quantity		1	1	1	1	1
Type of compressor		Rotary	Rotary	Rotary	Scroll	Scroll
Fan quantity		1	1	1	1	1
Fan power	W	120	120	150	150	150
Fan rotation speed	RPM	850	850	850	850	850
Ventilation		Horizontal	Horizontal	Horizontal	Horizontal	Horizontal
Sound pressure level (at 1 metre)	dB(A)	51	54	56	56	56
Hydraulic connection	mm	50	50	50	50	50
Nominal water flow*	m <sup>3</sup> /h	2,5	3,4	5	5,2	6
Water pressure drop (max)	kPa	10	10	12	12	12
Unit net dimensions (L/I/h)	mm	1025/455/660	1025/455/660	1140/470/875	1140/470/875	1140/470/875
Unit shipping dimensions (L/I/h)	mm	1130/470/760	1130/470/760	1240/500/980	1240/500/980	1240/500/980
Net weight / shipping weight	kg	57/71	61/75	80/98	106/124	106/124



\* Value at +/- 5% under the following conditions: Exterior temperature = 15°C (59°F) / IHR = 71% / Water inflow temperature = 26°C (78.8°F) / ΔT water 2°C (3.6°F).  
According to the NF 414 standard.

## 2. SPECIFICATIONS (continued)

---

### 2.2 Operating range

Use the swimming pool heat pump unit within the following ranges of temperature and humidity to ensure safe and efficient operation.

	Heating mode 	Cooling mode 
Outside temperature	+2°C ~ +35°C	+7°C ~ +43°C
Water temperature	+12°C ~ +40°C	+8°C ~ +40°C
Relative humidity	< 80%	< 80%
Setting range from the set point	+15°C ~ +40°C	+8°C ~ +35°C



***If the temperature or humidity does not correspond to these conditions, the security measures could be activated and the swimming pool heat pump unit may no longer work.***

## 2. SPECIFICATIONS (continued)

---

### 2.3 Dimensions

Models: ENP1M/ENP2M

Unit: mm

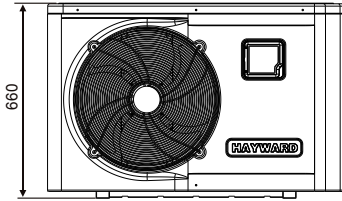

Frontal view

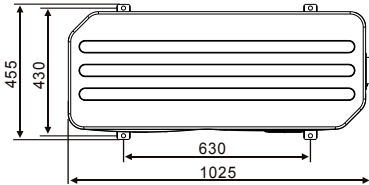
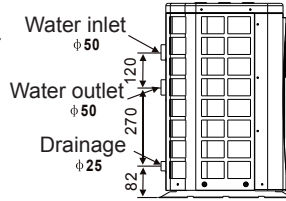

Overhead view

Models: ENP3M/ENP24M/ENP5M

Unit: mm

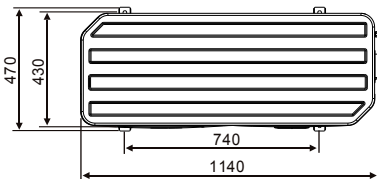
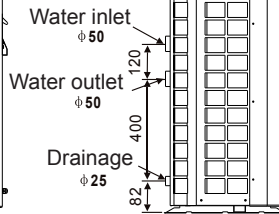
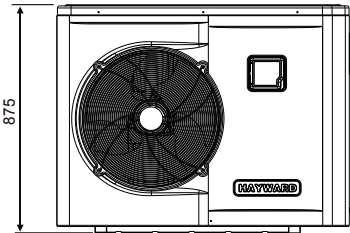

# 3. INSTALLATION AND CONNECTION

## 3.1 Functional Diagram

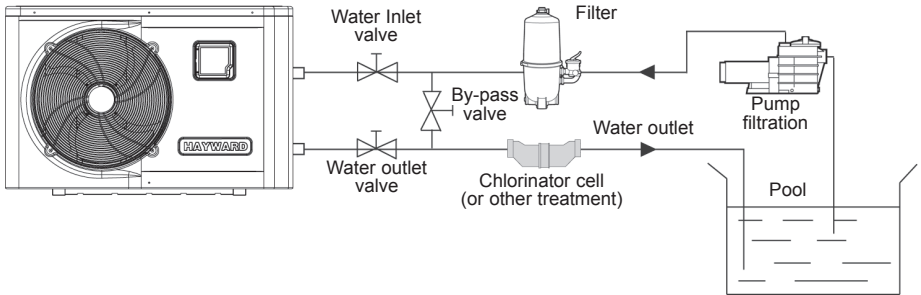

Note: The swimming pool heat pump unit is sold without any treatment or filtration equipment. The components presented in the diagram are spare parts to be supplied by the installer.

## 3.2 Heat pump



**Place the heat pump outdoors and away from any enclosed technical space.**

**Placed under a shelter, the minimum required distances mentioned below must be respected in order to avoid any risk of air recirculation and a deficiency in the unit's overall performance.**

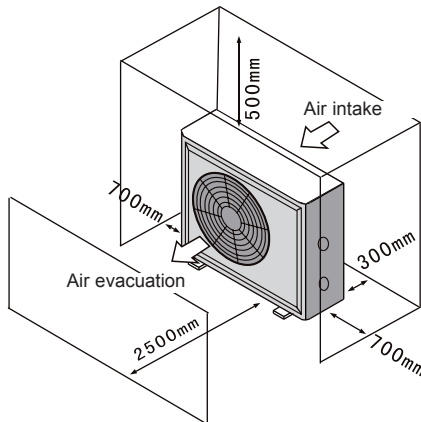

### 3. INSTALLATION AND CONNECTION (continued)

---



*It is advised to install the unit on a dissociated cement block or a mounting bracket designed for this use and to set up the unit on the supplied rubber bushing (fastenings and washers not supplied).*

*The maximum installation distance between the unit and the swimming pool is 15 metres.*

*The total length of the piping to and from the unit is 30 metres.*

*Insulate both the above ground and buried hydraulic piping.*

#### 3.3 Hydraulic connection

The unit is supplied with two 50 mm Ø union connections. Connect the water inlet to the heat pump coming from the filtration group then connect the water outlet to the heat pump at the water conduit going to the pool (see diagram below).

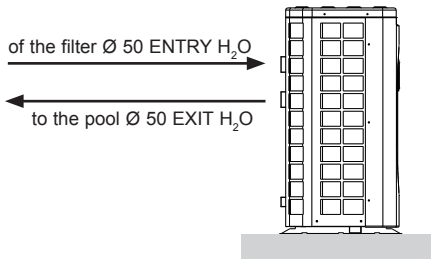

Install a by-pass valve between the heat pump entrance and exit.



*If an automatic distributor or an electrolyser is used, it should be installed imperatively after the heat pump with the goal of protecting the titanium condenser against an elevated concentration of chemicals.*



*Be sure to install the by-pass valve and the supplied union connections at the water inlet and outlet level in order to simplify purging during the winter period and to facilitate access when disassembling for maintenance.*



## 3. INSTALLATION AND CONNECTION (continued)

### 3.4 Electrical connection



**Electrical installation and wiring for this equipment must be in conformity with local installation standards.**

F	NF C15-100	GB	BS7671:1992
D	DIN VDE 0100-702	EW	EVHS-HD 384-7-702
A	ÖVE 8001-4-702	H	MSZ 2364-702/1994/MSZ 10-553 1/1990
E	UNE 20460-7-702 1993, RECBT ITC-BT-31 2002	M	MSA HD 384-7-702.S2
IRL	Wiring Rules + IS HD 384-7-702	PL	PN-IEC 60364-7-702:1999
I	CEI 64-8/7	CZ	CSN 33 2000 7-702
LUX	384-7.702 S2	SK	STN 33 2000-7-702
NL	NEN 1010-7-702	SLO	SIST HD 384-7-702.S2
P	RSIUEE	TR	TS IEC 60364-7-702



**Verify that the available electrical power supply and the network frequency correspond to the required operating current taking into account the appliance's specific location, and the current required to supply any other appliance connected to the same circuit.**

**ENP 1M 230 V~ +/- 10% 50 HZ 1 Phase**

**ENP 2M 230 V~ +/- 10% 50 HZ 1 Phase**

**ENP 3M 230 V~ +/- 10% 50 HZ 1 Phase**

**ENP 4M 230 V~ +/- 10% 50 HZ 1 Phase**

**ENP 5M 230 V~ +/- 10% 50 HZ 1 Phase**

**See the corresponding wiring diagram in the appendix.**

**The connection box is located on the right side of the unit. Three connections are designed for the power supply and two are for controlling the filter pump (Enslavement).**

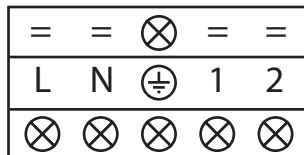

Power supply  
230V~ / 50Hz

Output 230V~  
Enslavement filtration pump 20A max

### 3. INSTALLATION AND CONNECTION (continued)

---



*The electrical power supply must have, when appropriate, a fuse protection device like a feed motor (aM) or D curve circuit breaker as well as a differential circuit breaker 30mA (see following table).*

Models		ENP1M	ENP2M	ENP3M	ENP4M	ENP5M
Power supply	V/Ph/Hz	230 V~ 1/50 Hz	230 V~ 1/50 Hz	230 V~ 1/50 Hz	230 V~ 1/50 Hz	230 V~ 1/50 Hz
aM type fuse calibre	A	10 aM	12 aM	16 aM	20 aM	25 aM
Curve D circuit breaker	A	10 D	12 D	16 D	20 D	25 D



*Always shut down the main power supply before opening the electrical control box.*

#### 3.5 Initial start-up

Start-up procedure - After installation is complete, follow these steps:

- 1) Rotate the fan by hand to verify that it can turn freely, and that the turbine is correctly affixed to the motor shaft.
- 2) Ensure that the unit is connected correctly to the main power supply (see the wiring diagram in the appendix).
- 3) Activate the filtration pump.
- 4) Verify that all water valves are open and that the water flows toward the unit before switching on the heating or cooling mode.
- 5) Verify that the drainage hose is correctly affixed and that it causes no obstructions.
- 6) Activate the unit power supply, then press the On/Off button  on the control panel.
- 7) Ensure that no ALARM code is displayed when the unit is ON (see troubleshooting guide).

### 3. INSTALLATION AND CONNECTION (continued)

---

- 8) Set the water flow using the by-pass valve (see § 3.6 and 2.1), as provided for by each model, to obtain an Entry/Exit temperature of 2°C.
- 9) After running for several minutes, verify that the air exiting the unit is cool (between 5 and 10°).
- 10) With the unit operating, turn off the filter pump. The unit should automatically turn off and display error code E03.
- 11) Allow the unit and the pool pump to run 24 hours per day until the desired water temperature has been reached. When the set water inlet temperature is reached, the unit will turn off. It will automatically restart (as long as the pool pump is running) if the pool temperature is at least 0.5°C below the set temperature.

**Water flow switch** - The unit is equipped with a flow switch that turns on the heat pump when the pool filtration pump is running, and deactivates it when the filtration pump is out of order. If the water is low, the E03 alarm code will appear on the regulator (See § 6.4).

**Time delay** - The unit is equipped with a time delay of 3 minutes in order to protect the control circuit components, to eliminate restart cycling and contactor chatter. Thanks to this time delay, the unit automatically restarts approximately 3 minutes after each control circuit interruption. Even a brief power interruption will activate the restart time delay.

### 3. INSTALLATION AND CONNECTION (continued)

---

#### 3.6 Water flow setting

With the water entry and exit valves being open, adjust the by-pass valve in order to obtain a difference of 2°C between the inflow and outflow temperature (see principle diagram § 3.1). You can verify the switch by seeing the entry/exit temperatures directly on the control panel.

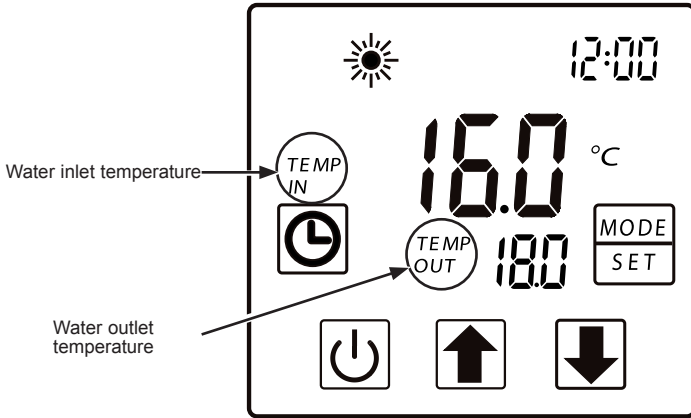

Note: Opening the by-pass valve creates a weaker flow, which leads to an increase in  $\Delta T$ .

Closing the by-pass valve creates a stronger flow, which leads to a decrease in  $\Delta T$ .

## 4. USER INTERFACE

---

### 4.1 General presentation

The heat pump is equipped with a digital control panel with a touch screen, electronically connected and pre-set at the factory in heating mode.

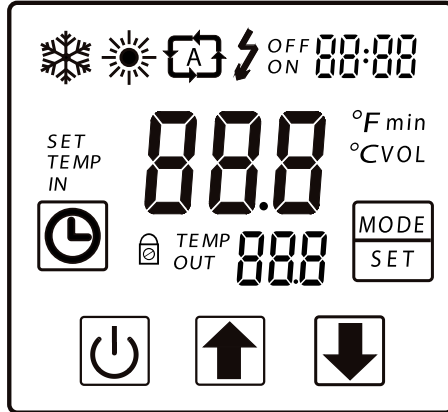

#### Key



Symbol Cooling Mode



Symbol Heating Mode



Automatic mode



Clock and timer settings



Selection and settings button



On/Off button and return



Scroll down



Scroll up

## 4. USER INTERFACE (continued)

---

### OFF Mode

When the heating pump is in sleep mode (OFF Mode) “OFF” is displayed on the command screen.

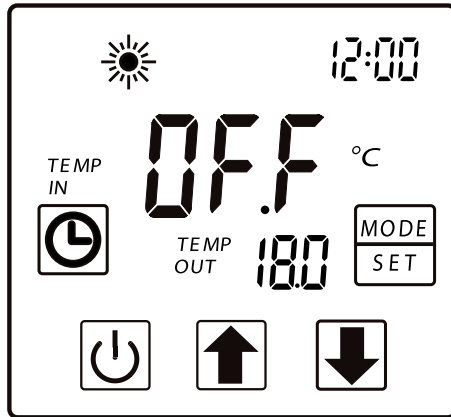

### ON Mode



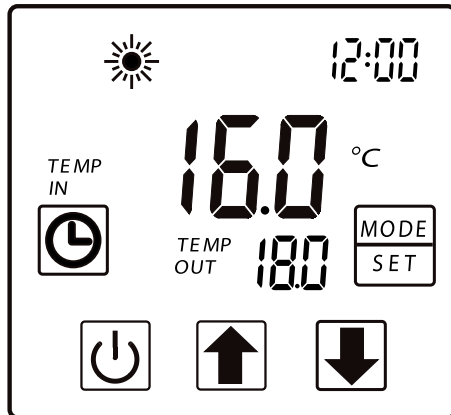



When the heating pump is running or regulating (ON Mode), the inlet and outlet water temperatures are displayed on the command screen.



## 4. USER INTERFACE (continued)

---

### 4.2 Clock settings







Press 2 times on , the blinking time display then set the time with the arrows  or  then press one more time  to set the minutes with the arrows  or . Press  to validate.

Note: The settings will be automatically saved if no button is pressed after 5 seconds, if not press  to validate.

### 4.3 Timer function settings









Setting this function is necessary if you would like to run the heat pump for a shorter period than what is defined by the filtration clock. Therefore, you can program a deferred start and an anticipated stop or simply stop a certain timeframe from running (at night, for example).

#### Start Program (Timer ON) / Start

- 1) Press  2 seconds, Timer "ON" blinks.
- 2) Press  to set the hour using the buttons  .
- 3) Press  to set the minutes using the buttons  .

It is automatically saved after 5 seconds of no action.





#### Stop Program (Timer OFF) / Stop

- 1) Press  2 seconds, Timer "ON" blinks then press  3 times in a row until timer "OFF" blinks.
- 2) Press  to set the hour using the buttons  .
- 3) Press  to set the minutes using the buttons  .

## 4. USER INTERFACE (continued)

---

### Turn off the Timer (Timer ON and OFF) / Off and On

- 1) Press  2 seconds, Timer "ON".
- 2) Press  to delete the programme.
- 3) Press  2 seconds timer "ON" blinks then press  2 seconds, Timer "OFF" blinks.
- 4) Press  to delete the programme.

### 4.4 Operating mode choice: heating or cooling

#### In Mode "OFF" or "ON"

Press the button  2 seconds to go from heating mode to cooling mode, and vice-versa.

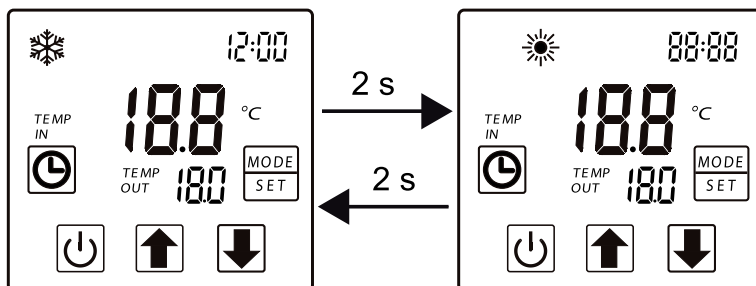





## 4. USER INTERFACE (continued)

---



### 4.5 Settings and visualisation from the set point (desired water temperature)

#### In Mode “OFF” and Mode “ON”



Press the buttons  or  to define the desired set point. The settings are made with a precision of 0.5 °C.





*It is recommended to never surpass 30°C to avoid alteration of the liners.*

Note: When on or off, it suffices to press the button  or  to see or modify the set point.

### 4.6 Locking and unlocking the touch screen

Press the On/Off button  5 seconds until it beeps and this symbol appears .

To unlock, press  5 seconds until it beeps and this symbol disappears .

## 5. MAINTENANCE AND WINTERISING

---

### 5.1 Maintenance

These maintenance operations must be carried out once per year in order to guarantee the longevity and the good working condition of the heat pump.

- Clean the coil with the help of a soft brush or jet of air or water (**Warning, never use a high pressure cleaner**).
- Verify that the drains flow well.
- Verify the tightening of the hydraulic and electrical connections
- Verify the hydraulic sealing of the condenser.



***Before any maintenance operation, the heating pump must be disconnected from any electrical current source. The maintenance operations must only be carried out by personnel that is qualified and authorised to handle liquid refrigerants.***

### 5.2 Winterising

- Put the heat pump in “OFF” mode.
- Cut the power supply to the heat pump.
- Empty the condenser with the help of the drain to avoid any risk of deterioration. (high risk of freezing).
- Close the by-pass valve and unscrew the entry/exit connection unions.
- Eliminate the maximum amount of residual stagnant water from the condenser with the help of an air gun.
- Close the water entry and exit areas of the heating pump to avoid introducing foreign bodies.
- Cover the heating pump with a dedicated winterising case.



***Any damage caused by poor winterising maintenance will lead to cancellation of the warranty.***

# 6. APPENDIX

## 6.1 Electrical diagrams

### ENP1M

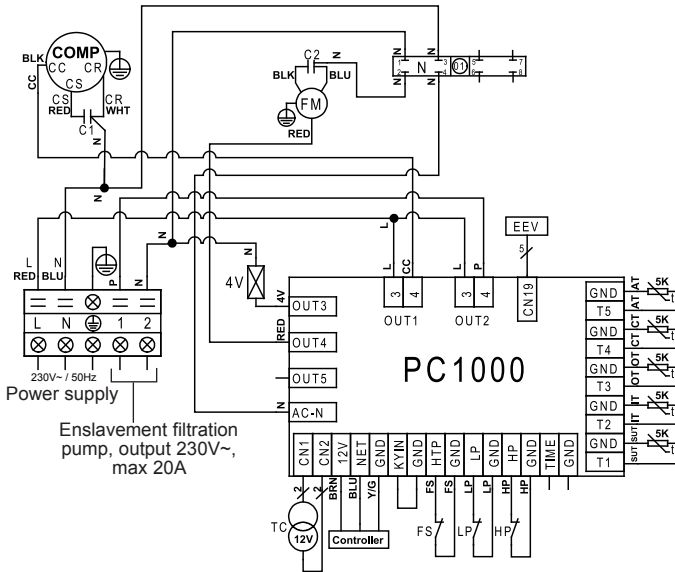

**REMARKS:**

- 1. AT: AIR TEMPERATURE SENSOR
- 2. COMP: COMPRESSOR
- 3. CT: EVAPORATOR TEMPERATURE SENSOR
- 4. EEV: ELECTRONIC EXPANSION VALVE
- 5. FM: FAN MOTOR
- 6. FS: WATER PRESENCE DETECTOR
- 7. HP: HIGH PRESSURE SWITCH

- 8. IT: WATER INLET TEMPERATURE SENSOR
- 9. LP: LOW PRESSURE SWITCH
- 10. OT: OUTLET WATER TEMPERATURE SENSOR
- 11. SUT: ASPIRATION TEMPERATURE SENSOR
- 12. TC: TRANSFORMER 230V~/ 12V~
- 13. 4V: 4 WAYS VALVE
- 14.C1: COMPRESSOR CONDENSER
- 15.C2: CONDENSER FAN

# 6. APPENDIX (continued)

## ENP2M

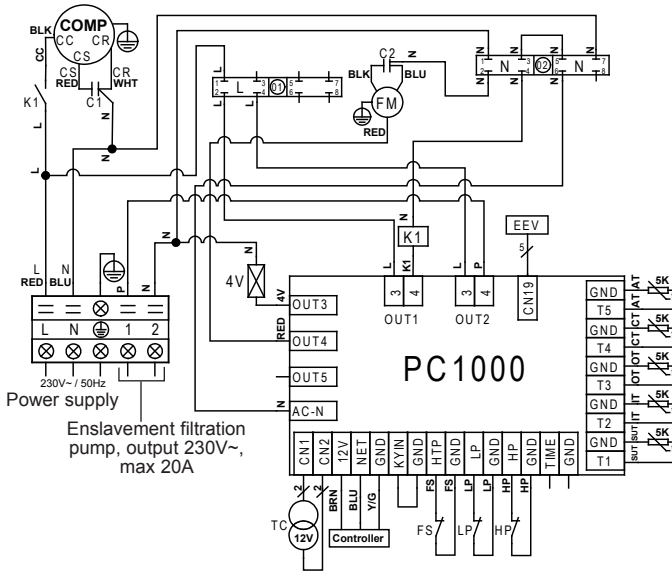

Enslavement filtration pump, output 230V~, max 20A

### REMARKS:

1. AT: AIR TEMPERATURE SENSOR
2. COMP: COMPRESSOR
3. CT: EVAPORATOR TEMPERATURE SENSOR
4. EEV: ELECTRONIC EXPANSION VALVE
5. FM: FAN MOTOR
6. FS: WATER PRESENCE DETECTOR
7. HP: HIGH PRESSURE SWITCH
8. IT: WATER INLET TEMPERATURE SENSOR

9. LP: LOW PRESSURE SWITCH
10. OT: OUTLET WATER TEMPERATURE SENSOR
11. SUT: ASPIRATION TEMPERATURE SENSOR
12. TC: TRANSFORMER 230V~/ 12V~
13. 4V: 4 WAYS VALVE
14. K1: RELAY
15. C1: COMPRESSOR CAPACITOR
16. C2: FAN MOTOR CAPACITOR

# 6. APPENDIX (continued)

## ENP3M

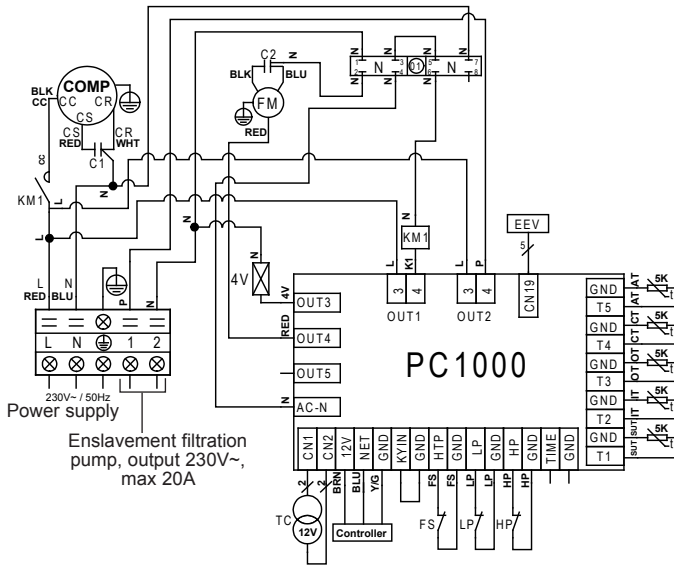

Enslavement filtration pump, output 230V~, max 20A

### REMARKS:

1. AT: AIR TEMPERATURE SENSOR
2. COMP: COMPRESSOR
3. CT: EVAPORATOR TEMPERATURE SENSOR
4. EEV: ELECTRONIC EXPANSION VALVE
5. FM: FAN MOTOR
6. FS: WATER PRESENCE DETECTOR
7. HP: HIGH PRESSURE SWITCH
8. IT: WATER INLET TEMPERATURE SENSOR

9. LP: LOW PRESSURE SWITCH
10. OT: OUTLET WATER TEMPERATURE SENSOR
11. SUT: ASPIRATION TEMPERATURE SENSOR
12. TC: TRANSFORMER 230V~ / 12V~
13. 4V: 4 WAYS VALVE
14. KM1: POWER CAPACITOR
15. C1: COMPRESSOR CAPACITOR
16. C2: FAN MOTOR CAPACITOR

# 6. APPENDIX (continued)

## ENP4M

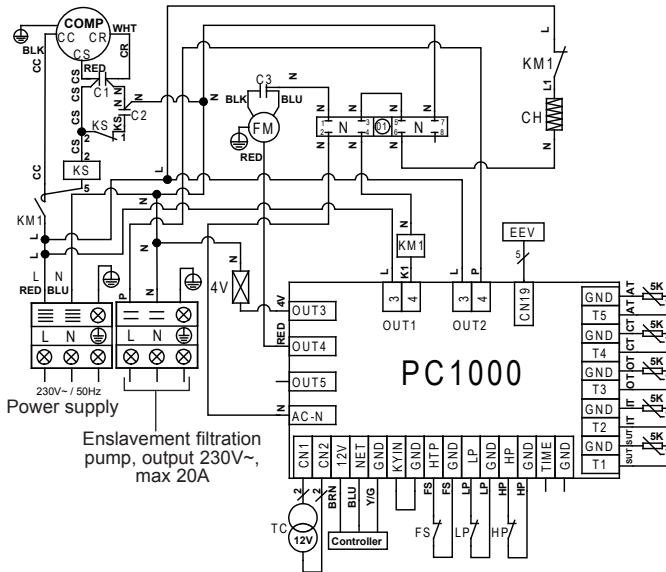

### REMARKS:

1. AT: AIR TEMPERATURE SENSOR
2. COMP: COMPRESSOR
3. CH: SUMP HEATER
4. CT: EVAPORATOR TEMPERATURE SENSOR
5. EEV: ELECTRONIC EXPANSION VALVE
6. FM: FAN MOTOR
7. FS: WATER PRESENCE DETECTOR
8. HP: HIGH PRESSURE SWITCH
9. IT: WATER INLET TEMPERATURE SENSOR

10. KS: RELAY COIL FOR COMPRESSOR START-UP
11. LP: LOW PRESSURE SWITCH
12. OT: OUTLET WATER TEMPERATURE SENSOR
13. SUT: ASPIRATION TEMPERATURE SENSOR
14. TC: TRANSFORMER 230V~ / 12V~
15. 4V: 4 WAYS VALVE
16. KM1: POWER CONTACTOR
17. C1: COMPRESSOR CAPACITOR
18. C2: FAN MOTOR CAPACITOR



# 6. APPENDIX (continued)

## 6.2 Heating priority wiring

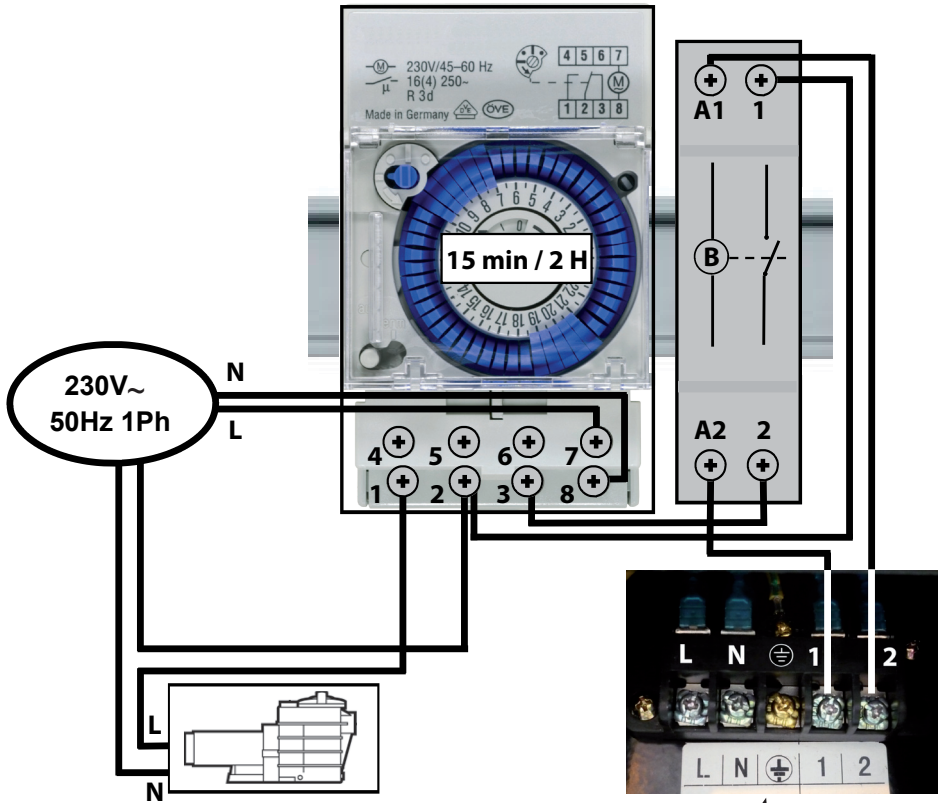

Outside of the filtration range, it is necessary to start a check of the water temperature by regularly starting the filtration pump (15 minutes every 2 hours). If during this check period the heating pump is needed, it will start and maintain the heating priority.







## 6. APPENDIX (continued)

---

### 6.3 Exploded view and spare parts

#### ENP1M

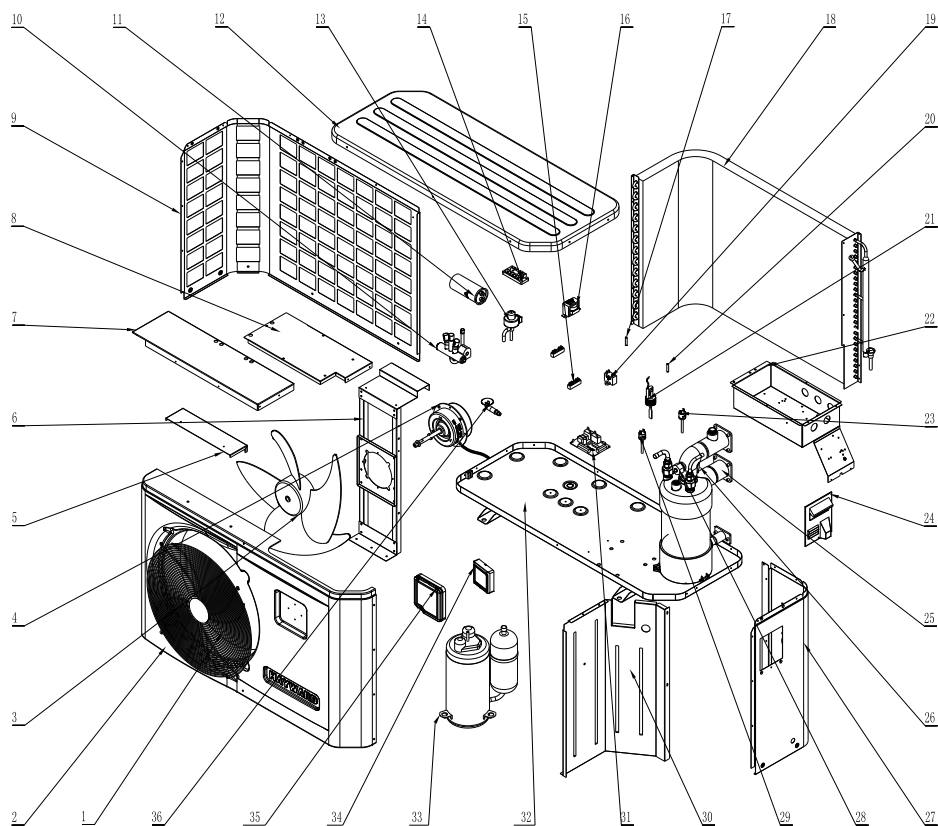

## 6. APPENDIX (continued)

### ENP1M

Mark	Ref.	Description	Mark	Ref.	Description
1	HWX321221008	Fan protection grille	19	HWX20003501	Compressor capacitor (3 $\mu$ F)
2	HWX320822002	Front panel	20	HWX20003242	Coil temperature sensor
3	HWX35002701	Fan blade	21	HWX200036005	Flow switch
4	HWX320821069	Fan motor	22	HWX321221078	Electrical box cover
5	HWX34043301	Protection panel	23	HWX20003603	High pressure switch
6	HWX32122175	Fan motor bracket	24	HWX320822008	Protection cover
7	HWX321221077	Support panel	25	HWX322512005	PVC-Titanium condenser
8	HWX321221079	Electrical box cover	26	HWX20003242	Water outlet sensor
9	HWX320821072	Back panel	27	HWX320821071	Right panel
10	HWX20011418	4 ways valve	28	HWX20003242	Water inlet sensor
11	HWX20003504	Compressor capacitor (35 $\mu$ F)	29	HWX20013605	Low pressure switch
12	HWX320822021	Top cover	30	HWX321221076	Center wall
13	HWX20031402	Electronic expansion valve	31	HWX950531145	PCB board
14	HWX40003901	Terminal block 5 connections	32	HWX320821007	Bottom panel
15	HWX20003909	Terminal block 2 connections	33	HWX200011077	Compressor
16	HWX200037003	Transformer 230V~ 12V~	34	HWX950531152	LCD controller
17	HWX20003242	Air temperature sensor	35	HWX200022068	Waterproof cover
18	HWX34061204	Fin coil	36	HWX34002203	Drain connector

## 6. APPENDIX (continued)

---

### ENP2M

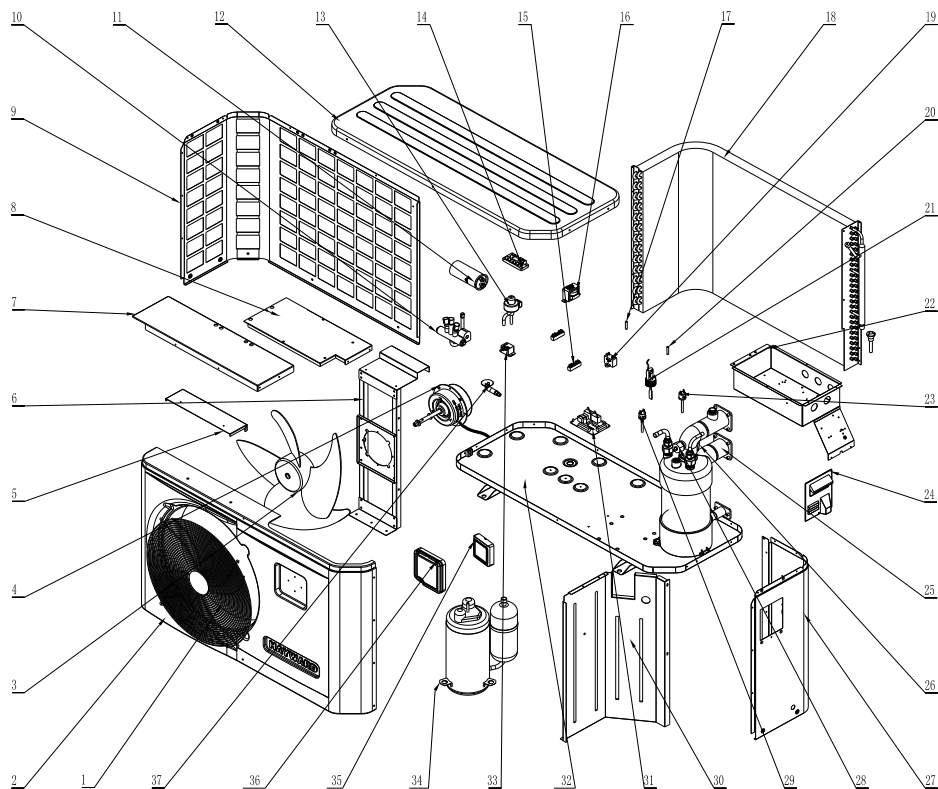

## 6. APPENDIX (continued)

### ENP2M

Mark	Ref.	Description	Mark	Ref.	Description
1	HWX321221008	Fan protection grille	19	HWX20003501	Compressor capacitor (3 $\mu$ F)
2	HWX320822002	Front panel	20	HWX20003242	Coil temperature sensor
3	HWX35002701	Fan blade	21	HWX200036005	Flow switch
4	HWX320821069	Fan motor	22	HWX321221078	Electrical box cover
5	HWX34043301	Protection panel	23	HWX20003603	High pressure switch
6	HWX32122175	Fan motor bracket	24	HWX320822008	Protection cover
7	HWX321221077	Support panel	25	HWX320812008	PVC-Titanium condenser
8	HWX321221079	Electrical box cover	26	HWX20003242	Water outlet sensor
9	HWX320821072	Back panel	27	HWX320821071	Right panel
10	HWX20041437	4 ways valve	28	HWX20003242	Water inlet sensor
11	HWX20003510	Compressor capacitor (60 $\mu$ F)	29	HWX20013605	Low pressure switch
12	HWX320822021	Top cover	30	HWX321221076	Center wall
13	HWX20021451	Electronic expansion valve	31	HWX950531145	PCB board
14	HWX40003901	Terminal block 5 connections	32	HWX320821007	Bottom panel
15	HWX20003909	Terminal block 2 connections	33	HWX20003619	Relay
16	HWX200037003	Transformer 230V~ 12V~	34	HWX20011163	Compressor
17	HWX20003242	Air temperature sensor	35	HWX950531152	LCD controller
18	HWX320812009	Fin coil	36	HWX200022068	Waterproof cover
			37	HWX34002203	Drain connector

# 6. APPENDIX (continued)

---

## ENP3M

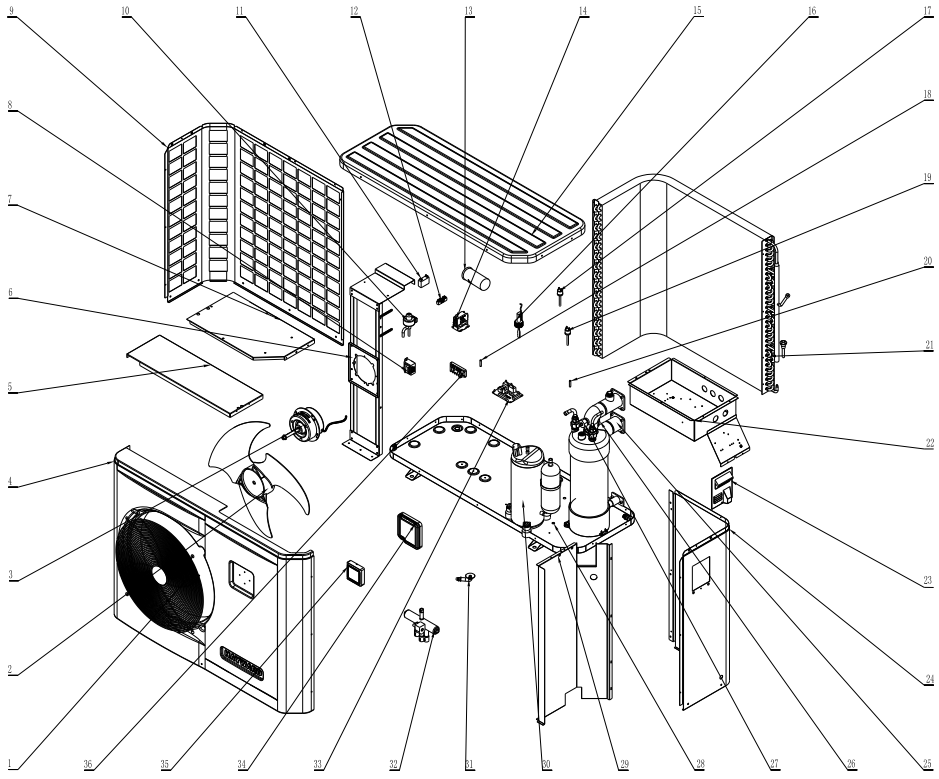

## 6. APPENDIX (continued)

### ENP3M

Mark	Ref.	Description	Mark	Ref.	Description
1	HWX340621049	Fan protection grille	19	HWX20013605	Low pressure switch
2	HWX20002705	Fan blade	20	HWX20003242	Air temperature sensor
3	HWX20013328	Fan motor	21	HWX351212001	Fin coil
4	HWX320922015	Front panel	22	HWX320921021	Electrical box cover
5	HWX320921025	Support panel	23	HWX320822008	Protection cover
6	HWX320921092	Fan motor bracket	24	HWX320921089	Right panel
7	HWX320921024	Electrical box cover	25	HWX320912013	PVC-Titanium condenser
8	HWX200037003	Transformer 230V~ 12V~	26	HWX20003242	Water outlet sensor
9	HWX320921009	Back panel	27	HWX20003242	Water inlet sensor
10	HWX20021451	Electronic expansion valve	28	HWX320921091	Bottom panel
11	HWX20003508	Fan motor capacitor (4 $\mu$ F)	29	HWX320921023	Center wall
12	HWX20003909	Terminal block 2 connections	30	HWX200011027	Compressor
13	HWX20003510	Compressor capacitor (60 $\mu$ F)	31	HWX34002203	Drain connector
14	HWX200036006	Compressor contactor	32	HWX20041437	4 ways valve
15	HWX320922016	Top cover	33	HWX950531145	PCB board
16	HWX200036005	Flow switch	34	HWX200022068	Waterproof cover
17	HWX20003603	High pressure switch	35	HWX950531152	LCD controller
18	HWX20003242	Coil temperature sensor	36	HWX40003901	Terminal block 5 connections

# 6. APPENDIX (continued)

## ENP4M

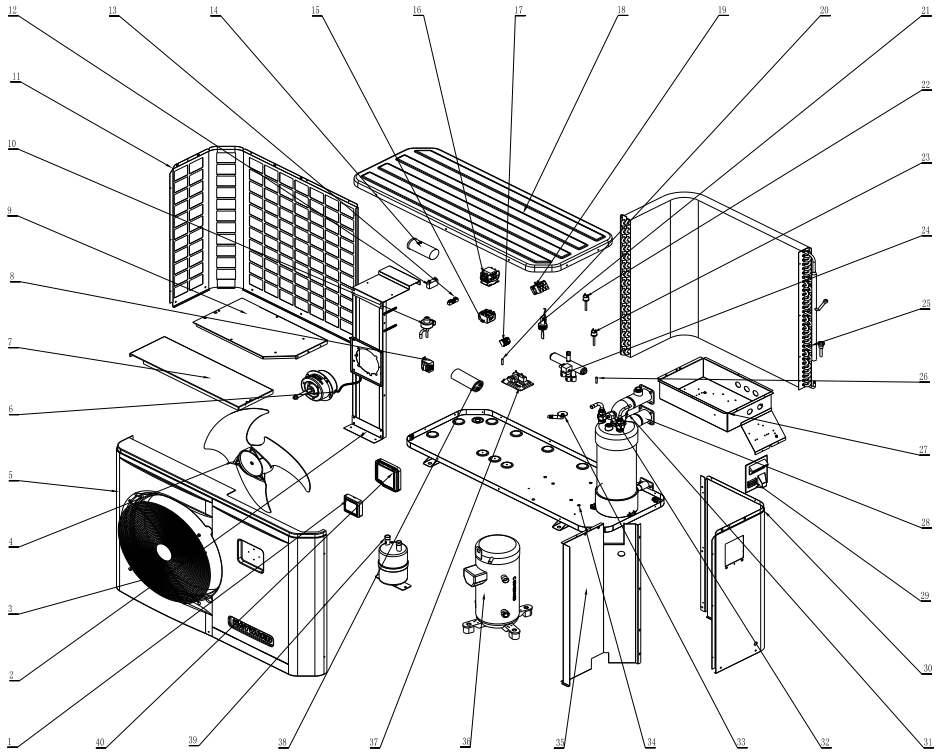



## 6. APPENDIX (continued)

### ENP4M

Mark	Ref.	Description	Mark	Ref.	Description
1	HWX950531152	LCD controller	21	HWX200036005	Flow switch
2	HWX320921092	Fan motor bracket	22	HWX20003603	High pressure switch
3	HWX340621049	Fan protection grille	23	HWX20013605	Low pressure switch
4	HWX20002705	Fan blade	24	HWX20011491	4 ways valve
5	HWX320922015	Front panel	25	HWX351212001	Fin coil
6	HWX20013328	Fan motor	26	HWX20003242	Air temperature sensor
7	HWX320921025	Support panel	27	HWX320921021	Electrical box cover
8	HWX200037003	Transformer 230V~- 12V~	28	HWX320912013	PVC-Titanium condenser
9	HWX320921024	Electrical box cover	29	HWX320822008	Protection cover
10	HWX20021451	Electronic expansion valve	30	HWX320921089	Right panel
11	HWX320921090	Back panel	31	HWX20003242	Water outlet sensor
12	HWX20003508	Fan motor capacitor (4 $\mu$ F)	32	HWX20003242	Water inlet sensor
13	HWX20003909	Terminal block 2 connections	33	HWX34002203	Drain connector
14	HWX20003524	Compressor capacitor (98 $\mu$ F)	34	HWX320921091	Bottom panel
15	HWX20003676	Relay	35	HWX320921023	Center wall
16	HWX200036007	Compressor contactor	36	HWX200011081	Compressor
17	HWX20003933	Terminal block 3 connections	37	HWX950531145	PCB board
18	HWX320922016	Top cover	38	HWX20003527	Compressor capacitor (70 $\mu$ F)
19	HWX20003920	Terminal block 6 connections	39	HWX35001401	Liquid tank
20	HWX20003242	Coil temperature sensor	40	HWX200022068	Waterproof cover

## 6. APPENDIX (continued)

---

### ENP5M

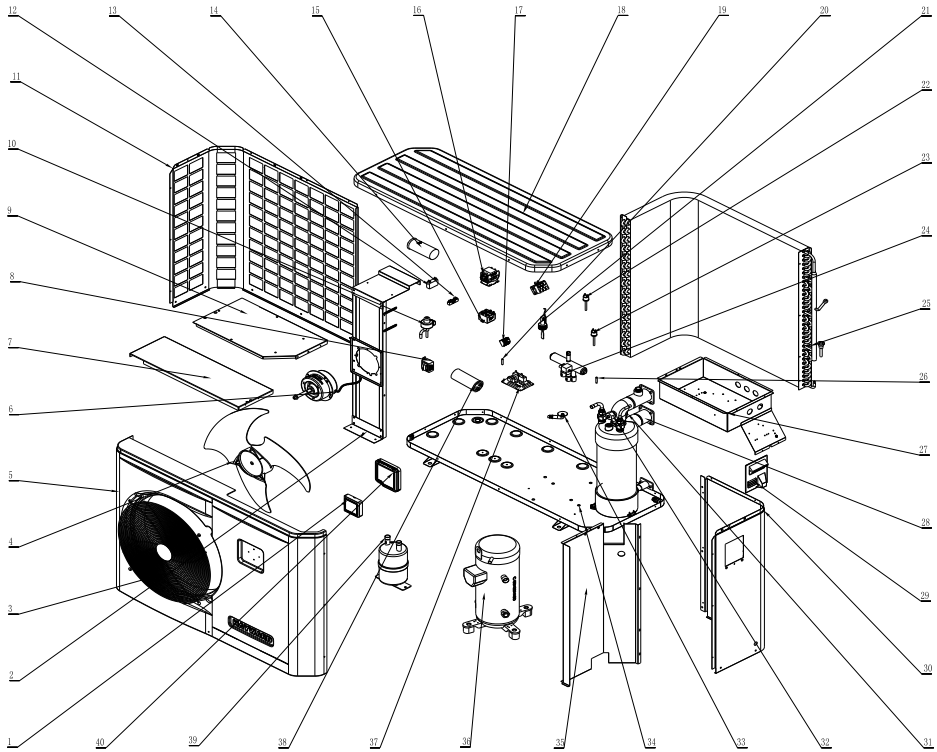

## 6. APPENDIX (continued)

### ENP5M

Mark	Ref.	Description	Mark	Ref.	Description
1	HWX950531152	LCD controller	21	HWX200036005	Flow switch
2	HWX320921092	Fan motor bracket	22	HWX20003603	High pressure switch
3	HWX340621049	Fan protection grille	23	HWX20013605	Low pressure switch
4	HWX20002705	Fan blade	24	HWX20011491	4 ways valve
5	HWX320922015	Front panel	25	HWX351212001	Fin coil
6	HWX20013328	Fan motor	26	HWX20003242	Air temperature sensor
7	HWX320921025	Support panel	27	HWX320921021	Electrical box cover
8	HWX200037003	Transformer 230V~- 12V~	28	HWX320912013	PVC-Titanium condenser
9	HWX320921024	Electrical box cover	29	HWX320822008	Protection cover
10	HWX200014151	Electronic expansion valve	30	HWX320921089	Right panel
11	HWX320921090	Back panel	31	HWX20003242	Water outlet sensor
12	HWX20003508	Fan motor capacitor (4 $\mu$ F)	32	HWX20003242	Water inlet sensor
13	HWX20003909	Terminal block 2 connections	33	HWX34002203	Drain connector
14	HWX20003524	Compressor capacitor (98 $\mu$ F)	34	HWX320921091	Bottom panel
15	HWX20003676	Relay	35	HWX320921023	Center wall
16	HWX200036007	Compressor contactor	36	HWX200011053	Compressor
17	HWX20003933	Terminal block 3 connections	37	HWX950531145	PCB board
18	HWX320922016	Top cover	38	HWX200035004	Compressor capacitor (80 $\mu$ F)
19	HWX20003920	Terminal block 6 connections	39	HWX35001401	Liquid tank
20	HWX20003242	Coil temperature sensor	40	HWX200022068	Waterproof cover

## 6. APPENDIX (continued)

### 6.4 Troubleshooting guide



***Certain operations must be carried out by an authorized technician.***

Problem	Error codes	Description	Solution
Water inlet sensor defect.	P01	The sensor is open or presents a short-circuit.	Verify or replace the sensor.
Water outlet sensor defect.	P02	The sensor is open or presents a short-circuit.	Verify or replace the sensor.
De-icing sensor defect.	P05	The sensor is open or presents a short-circuit.	Verify or replace the sensor.
Exterior temperature sensor defect.	P04	The sensor is open or presents a short-circuit.	Verify or replace the sensor.
The inlet and outlet difference in water temperature is too high.	E06	Water flow volume is insufficient, water pressure difference is too low/too high.	Verify the water flow, or system obstruction.
Antifreeze Protection Cold mode	E07	Water outlet quantity is too weak.	Verify the water flow, or the outlet water temperature sensor.
Level 1 antifreeze protection	E19	Air temperature or water inlet temperature is too weak.	
Level 2 antifreeze protection	E29	Air temperature or water inlet temperature is still too weak.	
High pressure protection	E01	Pressure of the refrigeration circuit is too high, or the water flow is too low, or the coil is obstructed or the air flow is too weak.	Verify the high pressure switch and the refrigeration circuit pressure. Verify the water or air flow. Verify that the flow switch is working correctly. Verify the water inlet/outlet valve openings. Verify the by-pass setting.
Low pressure protection	E02	Refrigeration circuit pressure is too weak, or air flow is too weak or the coil is obstructed.	Verify the low pressure switch and the refrigeration circuit pressure to determine if there is a leak. Clean the coil surface. Verify the fan rotation speed. Verify that there is free air flow to the coil.
Flow detector defect	E03	Water flow is insufficient or the detector is in short-circuit or defective.	Verify the water flow, verify the filtration pump and the flow detector to see if they have any possible problems.
Communication problem	EE8	Problem with the LED controller or the PCB connection.	Verify the cable connection.

## 6. APPENDIX (continued)

---

### 6.5 Warranty

#### WARRANTY CONDITIONS

HAYWARD warrants its products free from defects in material and workmanship for a period of two years from the date of purchase. A purchase proof with its date must be enclosed for any request for warranty. We invite you to keep your receipt.

HAYWARD warranty is limited to the replacement or repair, at its option, of defective products that have been used in normal conditions and according to the instructions leaflet, with no change in the product and that have been working only with genuine HAYWARD parts. Frost and chemical reaction damages are excluded of the warranty.

HAYWARD will not be responsible for any other costs (removal, labor...), neither direct or indirect damages caused by malfunction of a product.

To initiate a warranty claim and ask for repair or replacement of a product, please contact your dealer. No shipment to our factory will be accept without our preliminary written acceptance.

Wear parts are excluded of the warranty.





Hayward is a registered trademark of Hayward Industries, Inc.  
© 2011 Hayward Industries, Inc.

